







CST55 Series Signal Towers

Accessories:

	Base with integrated tube (RAL7040/RAL7035) (Ø24mm, 110mm long, plastic, incl. rubber seal)	960 009 16/960 009 20
	Tube with cable gland, Ø25mm	
	100mm	975 849 10
	250mm	975 849 25
	400mm	975 849 40
	800mm	975 849 80
	Base for tube mounting (Ø25mm, plastic, incl. rubber seal)	960 009 15
	Foldable base for tube mounting (Match Ø25mm aluminum tube, incl. rubber seal (RAL7040/RAL7035))	960 009 18/960 009 19
	Bracket for base mounting with concealed cable entry (incl. rubber seals)	960 000 55
	Bracket for tube mounting (incl. cable gland M16 x 1.5)	960 000 54

Technical diagrams

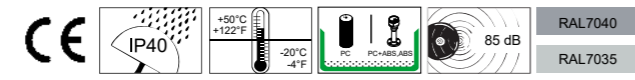
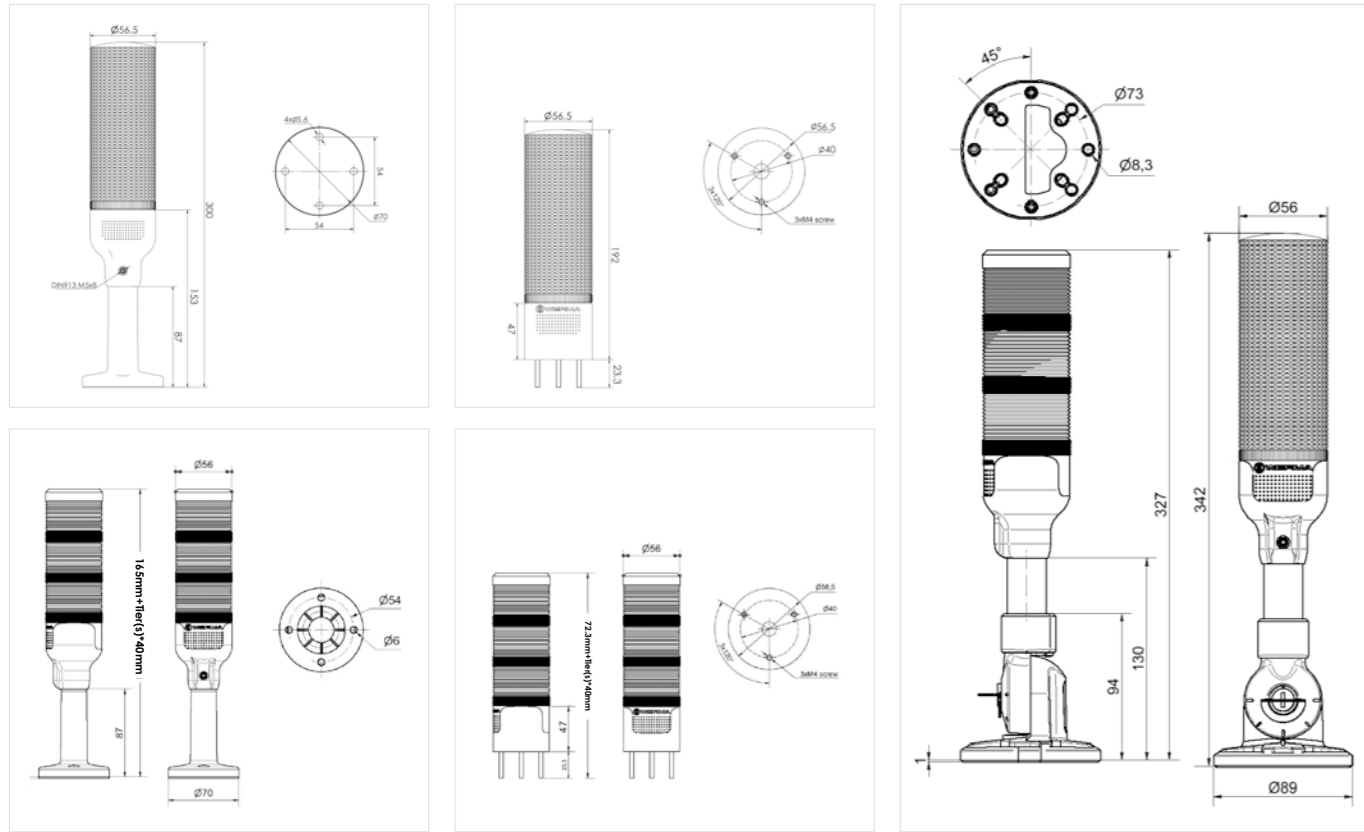

RAL7040
RAL7035

CST55 Series Signal Towers
– Inherit the classic,
upgrade color design



CST55 Series Signal Towers	
Voltage	24V DC (Positive and negative logic)
Protection Rate	IP40
Light	LED Permanent
Sound	Pulse(standard), Continuous tone(upon request)
Life Duration	50,000 hrs (LED)

1-5 TIERS PLUS BUZZER AS OPTION
MATCH MAJORITY APPLICATION

COMPLETE SET
INCLUDING STANDARD MOUNTING BRACKET AND WIRE

360° INTENSIVE VISIBILITY
FROM ALL THE POSITION

CLEARLY IDENTIFIED SIGNAL
BY UP TO 85DB PULSE TONE

INDUSTRIAL DESIGN LOOK
MATCH MODERN MACHINE APPEARANCE

CUSTOMER SPECIFIC*
SELECTABLE COLOR SEQUENCE

VARIOUS MOUNTINGS CHOICES
TUBE/BASE/
FOLDABLE BASE

In 2021, based on market demand, WERMA expanded the original CST55 signal towers and launched CST55C colorful series of signal towers. In addition to continuing the quality and cost-effectiveness of the classic CST55, the colorful appearance offers customers more choices. The classic transparent dome can prevent the interference of ambient light while the colorful dome can provide a more vivid and luminous lighting effect. For CST55 series signal towers, customers can choose tube mounting, base mounting, or foldable base mounting. Besides, CST55C can be customized with over 100 matching ways. There is always one way that can meet your needs. CST55 series products are equipped with standard wires, which not only can improve customer experience, but also reduce installation time and help save cost.

* Only CST55 C Series

CST55 Signal Towers

Tube mounting



Order specifications:

Tube mounting with bracket	
GN/YE/RD	659 110 55
GN/RD	659 120 55
BU/GN/YE/RD	659 150 55
Tube mounting with bracket and buzzer	
GN/YE/RD/Buzzer	659 310 55
GN/RD/Buzzer	659 320 55
BU/GN/YE/RD/Buzzer	659 350 55

Tube mounting (without bracket)



Order specifications:

Tube mounting without bracket	
GN/YE/RD	659 210 55
GN/RD	659 220 55
BU/GN/YE/RD	659 250 55
Tube mounting without bracket, with buzzer	
GN/YE/RD/Buzzer	659 410 55
GN/RD/Buzzer	659 420 55
BU/GN/YE/RD/Buzzer	659 450 55

Base mounting



Order specifications:

Base mounting without buzzer	
GN/YE/RD	659 610 55
GN/RD	659 620 55
BU/GN/YE/RD	659 650 55
Base mounting with buzzer	
GN/YE/RD/Buzzer	659 510 55
GN/RD/Buzzer	659 520 55
BU/GN/YE/RD/Buzzer	659 550 55

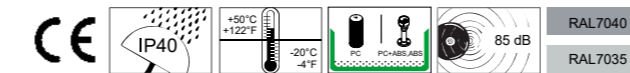

CST55 C Signal Towers

Tube mounting



Order specifications:

Tube mounting with bracket	
RD	659 130 55
GN/RD	659 230 55
GN/YE/RD	659 330 55
BU/GN/YE/RD	659 430 55
WH/ BU/GN/YE/RD	659 530 55
Tube mounting with bracket and buzzer	
RD/Buzzer	659 140 55
GN/RD/Buzzer	659 240 55
GN/YE/RD/Buzzer	659 340 55
BU/GN/YE/RD/Buzzer	659 440 55
WH/ BU/GN/YE/RD/Buzzer	659 540 55

Base mounting



Order specifications:

Base mounting without buzzer	
RD	659 910 55
GN/RD	659 920 55
GN/YE/RD	659 930 55
BU/GN/YE/RD	659 940 55
WH/ BU/GN/YE/RD	659 950 55
Base mounting with buzzer	
RD/Buzzer	659 960 55
GN/RD/Buzzer	659 970 55
GN/YE/RD/Buzzer	659 980 55
BU/GN/YE/RD/Buzzer	659 990 55
WH/ BU/GN/YE/RD/Buzzer	659 580 55

* CST55 C Signal towers color sequence can be customized

Foldable base set



Order specifications:

CST55	
GN/YE/RD	659 999 01
GN/YE/RD/Buzzer	659 999 02



Order specifications:

CST55 C	
GN/YE/RD	659 710 55
BU/GN/YE/RD	659 750 55
GN/YE/RD/Buzzer	659 810 55
BU/GN/YE/RD/Buzzer	659 850 55

